

Thermo Top 50 - Overview

04-2003

⚠ CAUTION

Troubleshooting requires comprehensive knowledge about the structure and theory of operation of the Thermo Top heater. Troubleshooting and repairs may only be performed by Webasto trained and certified, professionals.

Functional Description - Thermo Top

Switch On

Turn the control switch on to illuminate the indicator lamp; activate the heater glow pin, combustion air fan and the circulation pump. After 30 seconds the fuel pump starts and the combustion air fan operation is suspended for 3 seconds. Subsequently, the combustion air fan speed is increased in two ramps within 56 seconds to part load operation. After a stabilization phase (constant speed) of 15 seconds the combustion air fan speed is again increased in a ramp within 50 seconds to full load. After reaching full load, the glow pin is deactivated and the combustion air fan operation is increased. During the next 45 seconds and during normal heater operation, the glow pin functions as a flame sensor to monitor the flame condition. Once the start-up and stabilization periods have been completed the heater begins the automatically controlled heating operation. In case of a no-flame condition during start-up or a flameout during normal combustion operation, the heater will go into a "shut-down upon malfunction" state with a run-down of the combustion air fan.

Heating Operation

When the coolant reaches temperature the heater switches to the energy saving part load operation. A rise in coolant temperature above the upper threshold causes the heater to enter a control idle period. The circulation pump and the operation indicator light remain on during control idle. After cool-down of the coolant, the heater resumes full load operation. Another rise in coolant temperature above the upper threshold causes the heater to enter the control idle period again. A drop in the coolant temperature during part load operation due to an increased demand in heat will cause the heater to switch to full load operation.

Switch Off

Turning the switch off extinguishes the indicator lamp, combustion terminates and the shutdown phase commences. The circulation pump and the combustion air fan continue operation during the shutdown phase to cool the heater down and will be automatically switched off afterwards. The duration time and the combustion air fan speed during the shutdown phase depend on the heater operating condition at the time the heater is turned off.

Shut-down time duration is normally 180 seconds (3 minutes) when deactivated in full load operation and 100 seconds (1.6 minutes) when deactivated in part load operation.

Dependent on the software variant implemented in the control unit there might be time duration deviations from those shut-down periods as stated.

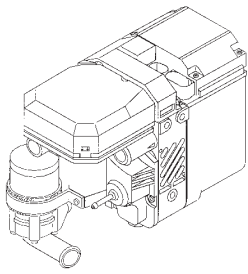

Thermo Top 50 - Diagnostic Flow Chart

ATTENTION!

Troubleshooting is normally limited to the isolation of defective components and provides information on defective wiring and connections.

The following possible causes for trouble have not been taken into consideration and must always be excluded as a possible cause for malfunctions:

- power supply to heater is less than 22 volts at main power connections (charge batteries and perform load test). See wiring diagram on page 5 for reference to power connections.
- blown fuses.
- corrosion on battery terminals for heater, electrical wiring, connections and fuses.
- loose contacts or connectors, wrong crimping on connectors.
- ensure heater and components have been correctly installed following all pertaining installation instructions.

Troubleshooting Steps

After 3 consecutive unsuccessful startup attempts, the heater will lock itself out from any further start attempts. The heater may also enter the lockout mode after experiencing an overheat condition. Before troubleshooting the heater, ensure heater is not in the "Lockout" mode by performing the following reset procedure:

1. Ensure switch is in the off position. Turn switch to the on position. Remove fuse F1 (15 Amp), refer to wiring diagram on page 5 for identification. Reinsert after 5 seconds.
2. Cycle switch off and then back on once more. Remove fuse F1 once again and reinsert after 5 seconds. Heater should attempt to start in 10 seconds after inserting fuse. Coolant must be below the lower threshold before heater will attempt to start.

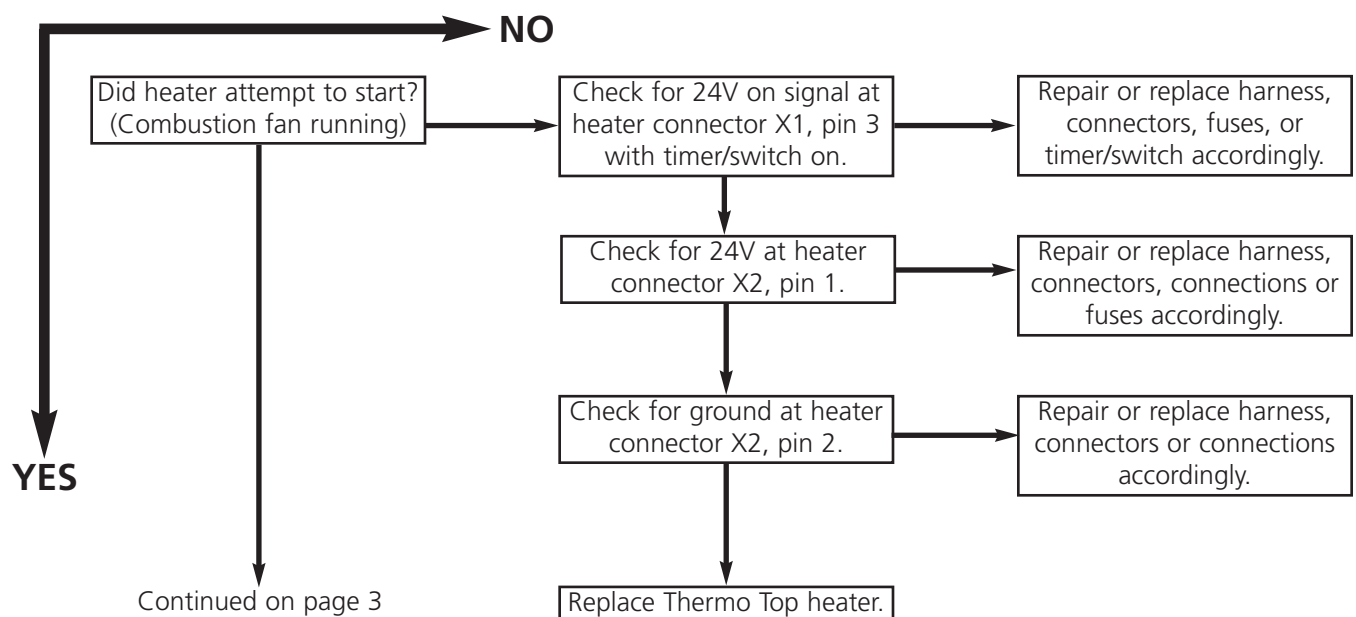

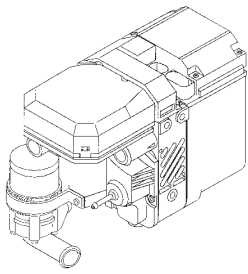

Thermo Top 50 - Diagnostic Flow Chart

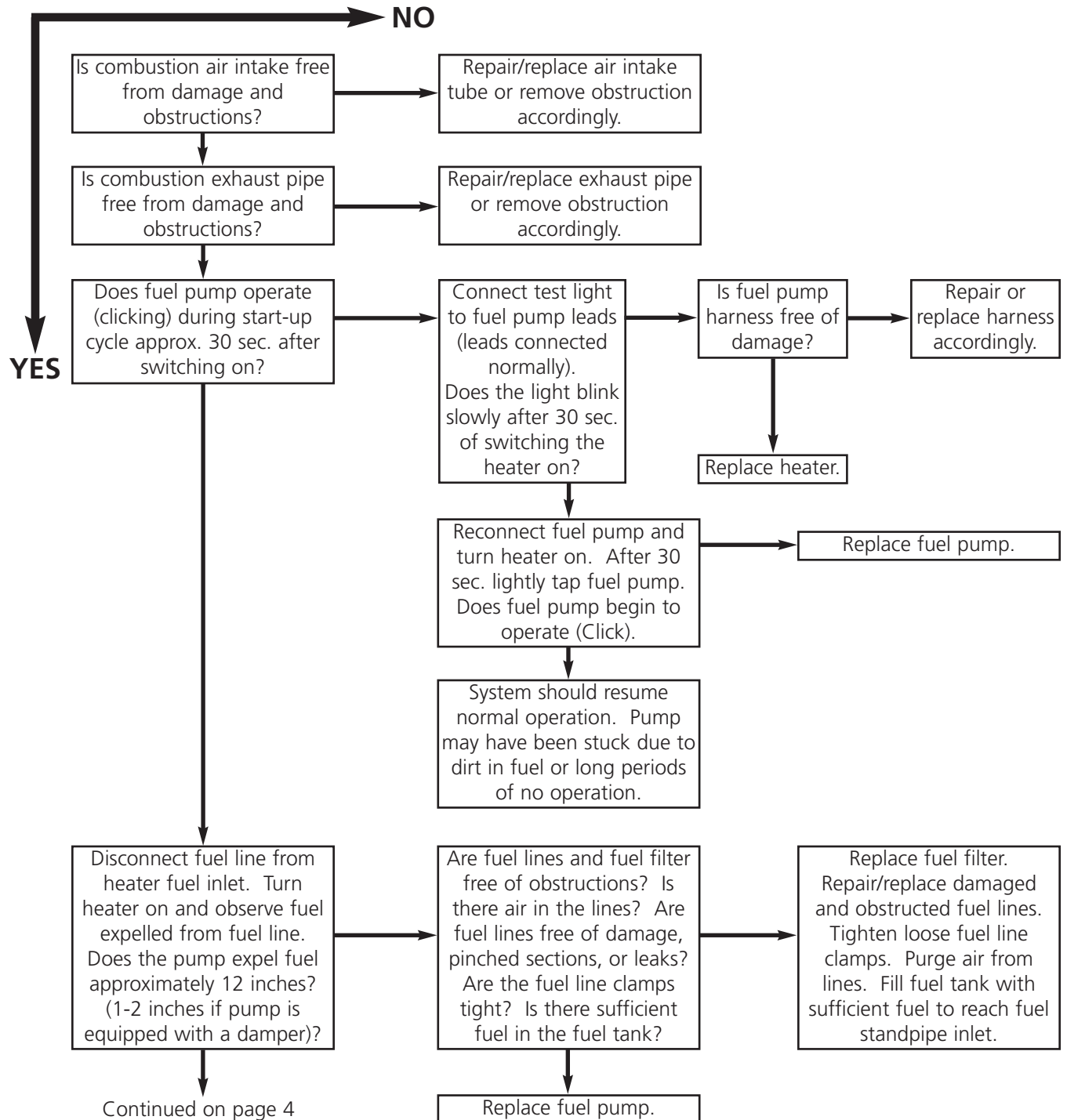

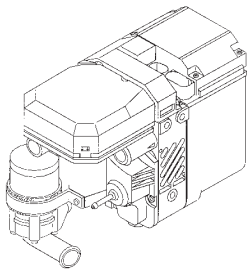

Thermo Top 50 - Diagnostic Flow Chart

⚠ CAUTION

Allow heater to cool down before disassembly of coolant circulating pump. Allow heater to cool down before attempting to restart.

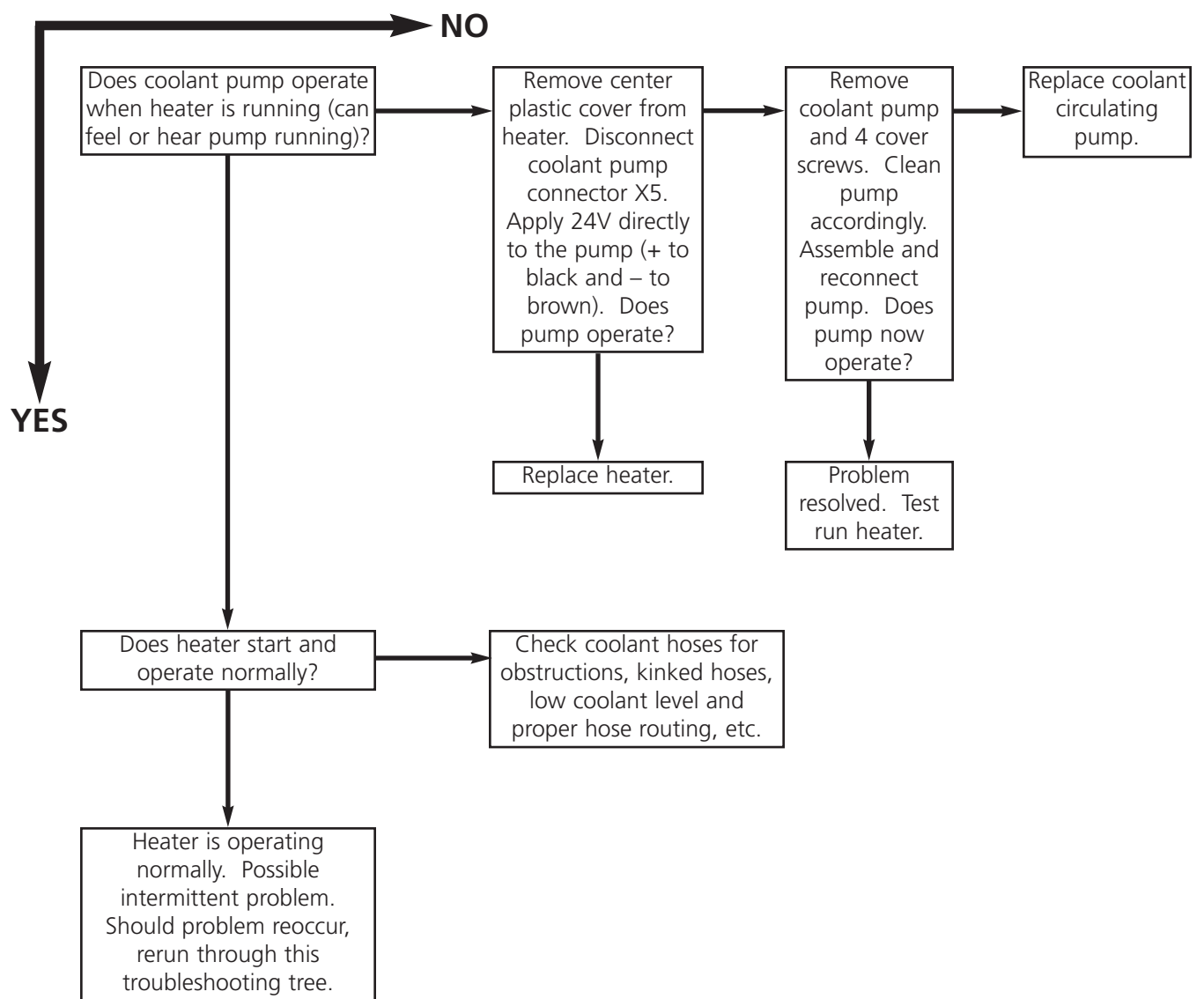

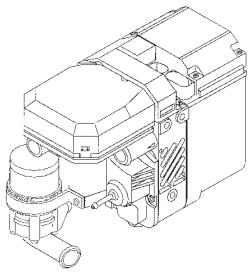

Thermo Top 50 - Fault Codes

Page 5

NOTE:

When the heater is activated by a switch, the types of malfunctions are indicated by coded flashing signals via the operation indicator light during the after-run period of the heater. Actual fault flash codes are preceded by 5 quick-pulse flashes. Count the slow flashes only. The sequence is repeated until the heater completes the after-run cycle and shuts down.

The coded flashing signals correspond to the numbers in the table below.

- F 01 No start-up
- F 02 Flame extinguished (at least > 5)
- F 03 Under-voltage or over-voltage
- F 04 Premature flame detection
- F 05 Circulating pump interruption or circulation pump short circuit
- F 06 Temperature sensor interruption or temperature sensor short-circuit
- F 07 Metering pump interruption or metering pump short-circuit
- F 08 Fan motor interruption or fan motor short-circuit or incorrect fan motor speed
- F 09 Pencil-type glow plug/flame detector interruption or pencil-type glow plug/flame detector short-circuit
- F 10 Overheating

PC Diagnostics

A PC Diagnostics kit is available that allows for more thorough testing and troubleshooting of the heater and its components beyond the scope discussed in this document. Other functions such as reading values while the heater is in operation and printing out of fault codes is also available (user supplied computer and printer required).

Order PC Diagnostics Kit under P/N 92542F and the required adapter under P/N 92566A.



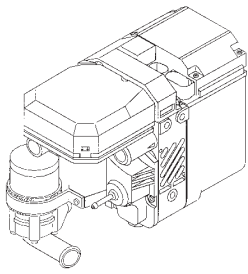

Thermo Top 50 - Wiring Schematic

